

SMART Digital - DDC

Installation and operating instructions



Declaration of conformity

GB Declaration of Conformity

We, Grundfos Alldos, declare under our sole responsibility that the products DDA, DDC and DDE, to which this declaration relates, are in conformity with these Council directives on the approximation of the laws of the EC member states:

- Machinery Directive (2006/42/EC).
Standards used: EN 809: 1998, EN ISO 12100-1+A1: 2009,
EN ISO 12100-2+A1: 2009.
- Low Voltage Directive (2006/95/EC) *.
Standard used: EN 60204-1+A1: 2009.
- EMC Directive (2004/108/EC).
Standards used: EN 61000-6-2: 2005, EN 61000-6-4: 2007.

* Only for products with operating voltage > 50 VAC or > 75 VDC.

Pfingztal, 1 November 2010

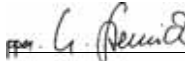

Ulrich Stemick
Technical Director
Grundfos Water Treatment GmbH
Reetzstr. 85, D-76327 Pfingztal, Germany

Person authorised to compile technical file and
empowered to sign the EC declaration of conformity.

Original installation and operating instructions

CONTENTS

	Page		
1. Safety instructions	3	6.8	Inputs/outputs 23
1.1 Identification of safety instructions in these instructions	3	6.8.1	Relay outputs 23
1.2 Qualification and training of personnel	4	6.8.2	External stop 24
1.3 Safety instructions for the operator/user	4	6.8.3	Empty and low-level signals 24
1.4 Safety of the system in the event of a failure in the dosing pump	4	6.9	Basic settings 24
1.5 Dosing chemicals	4	7. Service	24
2. General	5	7.1	Service system 25
2.1 Applications	5	7.2	Perform service 25
2.2 Improper operating methods	5	7.2.1	Dosing head overview 25
2.3 Warranty	5	7.2.2	Dismantling the diaphragm and valves 26
2.4 Nameplate	5	7.2.3	Reassembling the diaphragm and valves 26
2.5 Type key	6	7.3	Resetting the service system 26
2.6 Device overview	7	7.4	Repairs 26
3. Technical data/dimensions	8	8. Faults	27
3.1 Technical data	8	8.1	List of faults 27
3.2 Dimensions	10	8.1.1	Faults with error message 27
4. Assembly and installation	11	8.1.2	General faults 28
4.1 Pump assembly	11	9. Disposal	28
4.1.1 Requirements	11		
4.1.2 Align and install mounting plate	11		
4.1.3 Engage pump in mounting plate	11		
4.1.4 Adjust control cube position	11		
4.2 Hydraulic connection	12		
4.3 Electrical connection	13		
5. Commissioning	15		
5.1 Setting the menu language	15		
5.2 Deaerating the pump	16		
5.3 Calibrating the pump	16		
6. Operation	18		
6.1 Control elements	18		
6.2 Display and symbols	18		
6.2.1 Navigation	18		
6.2.2 Operating states	18		
6.2.3 Sleep mode (energy-saving mode)	18		
6.2.4 Overview of display symbols	19		
6.3 Main menus	20		
6.3.1 Operation	20		
6.3.2 Info	20		
6.3.3 Alarm	20		
6.3.4 Setup	20		
6.4 Operation modes	21		
6.4.1 Manual	21		
6.4.2 Pulse	21		
6.4.3 Analog 0/4-20 mA	22		
6.5 SlowMode	22		
6.6 Key lock	22		
6.7 Display Setup	23		
6.7.1 Units	23		
6.7.2 Additional display	23		

Warning



Prior to installation, read these installation and operating instructions. Installation and operation must comply with local regulations and accepted codes of good practice.

1. Safety instructions

These installation and operating instructions contain general instructions that must be observed during installation, operation and maintenance of the pump. It must therefore be read by the installation engineer and the relevant qualified operator prior to installation and start-up, and must be available at the installation location at all times.

1.1 Identification of safety instructions in these instructions

The safety instructions are identified by the following symbols:

Warning



If these safety instructions are not observed, it may result in personal injury!



If these safety instructions are not observed, it may result in malfunction or damage to the equipment!



Notes or instructions that make the job easier and ensure safe operation.

1.2 Qualification and training of personnel

The personnel responsible for the installation, operation and service must be appropriately qualified for these tasks. Areas of responsibility, levels of authority and the supervision of the personnel must be precisely defined by the operator. If necessary, the personnel must be trained appropriately.

Risks of not observing the safety instructions

Non-observance of the safety instructions may have dangerous consequences for the personnel, the environment and the pump and may result in the loss of any claims for damages.

It may lead to the following hazards:

- Personal injury from exposure to electrical, mechanical and chemical influences.
- Damage to the environment and personal injury from leakage of harmful substances.

1.3 Safety instructions for the operator/ user

The safety instructions described in these instructions, existing national regulations on health protection, environmental protection and for accident prevention and any internal working, operating and safety regulations of the operator must be observed. Information attached to the pump must be observed.

Leakages of dangerous substances must be disposed of in a way that is not harmful to the personnel or the environment.

Damage caused by electrical energy must be prevented, see the regulations of the local electricity supply company.

Before starting work on the pump, the pump must be in the 'Stop' operational state or be disconnected from the mains. The system must be pressureless!

Caution

Only original accessories and original spare parts should be used. Using other parts can result in exemption from liability for any resulting consequences.

1.4 Safety of the system in the event of a failure in the dosing pump

The dosing pump was designed according to the latest technologies and is carefully manufactured and tested.

If it fails regardless of this, the safety of the overall system must be ensured. Use the relevant monitoring and control functions for this.

Make sure that any chemicals that are released from the pump or any damaged lines do not cause damage to system parts and buildings.

Caution

The installation of leak monitoring solutions and drip trays is recommended.

1.5 Dosing chemicals

Warning



Before switching the supply voltage back on, the dosing lines must be connected in such a way that any chemicals in the dosing head cannot spray out and put people at risk.

The dosing medium is pressurised and can be harmful to health and the environment.

Warning



When working with chemicals, the accident prevention regulations applicable at the installation site should be applied (e.g. wearing protective clothing).

Observe the chemical manufacturer's safety data sheets and safety instructions when handling chemicals!

Warning



If the diaphragm leaks or is broken, dosing liquid will escape from the discharge opening on the dosing head (see fig. 3).

Take suitable precautions to prevent harm to health and damage to property from escaping dosing liquid!

Check daily whether liquid is escaping from the discharge opening!

Changing the diaphragm, see section 7. Service.

A deaeration hose, which is routed into a container, e.g. a drip tray, must be connected to the deaeration valve.

Caution

The dosing medium must be in liquid aggregate state!

Caution

Observe the freezing and boiling points of the dosing medium!

The resistance of the parts that come into contact with the dosing medium, such as the dosing head, valve ball, gaskets and lines, depends on the medium, media temperature and operating pressure.

Caution

Ensure that parts in contact with the dosing media are resistant to the dosing medium under operating conditions, see data booklet!

Should you have any questions regarding the material resistance and suitability of the pump for specific dosing media, please contact Grundfos.

2. General

The DDC dosing pump is a self-priming diaphragm pump. It consists of a housing with stepper motor and electronics, a dosing head with diaphragm and valves and the control cube.



Excellent dosing features of the pump:

- Optimal intake even with degassing media, as the pump always works at full suction stroke volume.
- Continuous dosing, as the medium is sucked up with a short suction stroke, regardless of the current dosing flow, and dosed with the longest possible dosing stroke.

2.1 Applications

The pump is suitable for liquid, non-abrasive, non-flammable and non-combustible media strictly in accordance with the instructions in these installation and operating instructions.

Areas of application

- Drinking water treatment
- Waste water treatment
- Swimming pool water treatment
- Boiler water treatment
- CIP (Clean-In-Place)
- Cooling water treatment
- Process water treatment
- Wash plants
- Chemical industry
- Ultrafiltration processes and reverse osmosis
- Irrigation
- Paper and pulp industry
- Food and beverage industries

2.4 Nameplate

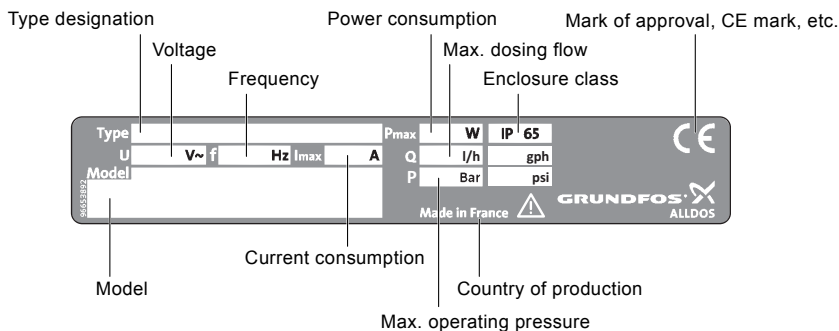

Fig. 1 Nameplate

2.2 Improper operating methods

The operational safety of the pump is only guaranteed if it is used in accordance with section 2.1 Applications.

Warning



Other applications or the operation of pumps in ambient and operating conditions, which are not approved, are considered improper and are not permitted. Grundfos cannot be held liable for any damage resulting from incorrect use.

Warning



The pump is NOT approved for operation in potentially explosive areas!

Warning



A sunscreen is required for outdoor installation!

2.3 Warranty

A guarantee claim in accordance with our general terms of sale and delivery is only valid if the following requirements are fulfilled:

- The pump is used in accordance with the information within this manual.
- The pump is not dismantled or incorrectly handled.
- The maintenance is carried out by authorised and qualified personnel.
- Original spare parts are used for repairs during maintenance.

2.5 Type key

The type key is used to identify the precise pump and is not used for configuration purposes.

Code	Example	DDC	6-	10	AR-	PP/	V/	C-	F-	3	1	U2U2	F	G
	Pump type													
	Max. flow [l/h]													
	Max. pressure [bar]													
	Control variant													
A	Standard													
AR	A with alarm relay and analog input													
	Dosing head material													
PP	Polypropylene													
PVC	PVC (polyvinyl chloride) (only up to 10 bar)													
PV	PVDF (polyvinylidene fluoride)													
SS	Stainless steel DIN 1.4401													
PVC-P3	PVC with Plus ³													
	Gasket material													
E	EPDM													
V	FKM													
T	PTFE													
	Valve ball material													
C	Ceramic													
SS	Stainless steel DIN 1.4401													
	Control cube position													
F	Front-mounted (can be changed to the right or left)													
	Voltage													
3	1 x 100-240 V, 50/60 Hz													
I	24-48 VDC**													
	Valve type													
1	Standard													
2	Spring-loaded (HV version)													
	Suction/discharge side connection													
U2U2	Hose, 4/6 mm, 6/9 mm, 6/12 mm, 9/12 mm													
U7U7	Hose 1/8" x 1/4"; 0.17" x 1/4"; 1/4" x 3/8"; 3/8" x 1/2"													
AA	Threaded Rp 1/4", female (stainless steel)													
VV	Threaded 1/4" NPT, female (stainless steel)													
XX	No connection													
	Installation set*													
I001	Hose, 4/6 mm (up to 7.5 l/h, 16 bar)													
I002	Hose, 9/12 mm (up to 60 l/h, 13 bar)													
I003	Hose 0.17" x 1/4" (up to 7.5 l/h, 16 bar)													
I004	Hose, 3/8" x 1/2" (up to 60 l/h, 10 bar)													
	Power plug													
F	EU (Schuko)													
B	USA, Canada													
G	UK													
I	Australia, New Zealand, Taiwan													
E	Switzerland													
J	Japan													
L	Argentina													
X	No plug (only 24-48 VDC)**													
	Design													
G	Grundfos Alldos													

*) Including: 2 pump connections, foot valve, injection unit, 6 m PE discharge hose, 2 m PVC suction hose, 2 m PVC deaeration hose (4/6 mm)

**) Available 2011

2.6 Device overview

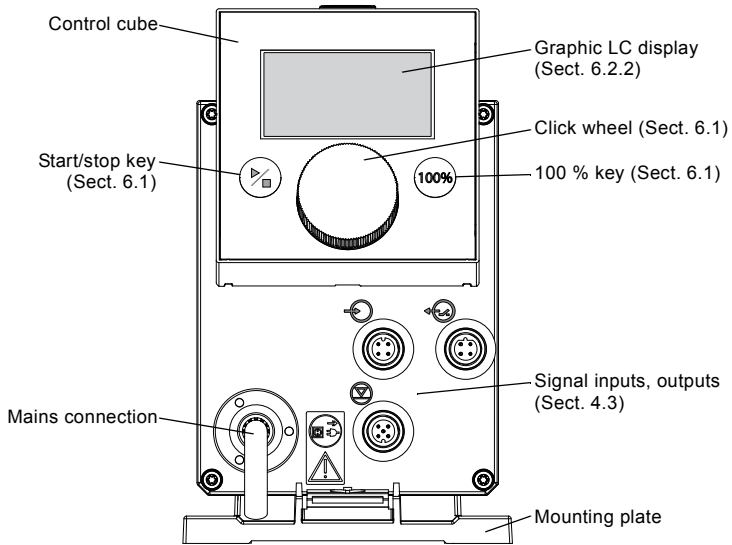

Fig. 2 Front view of the pump

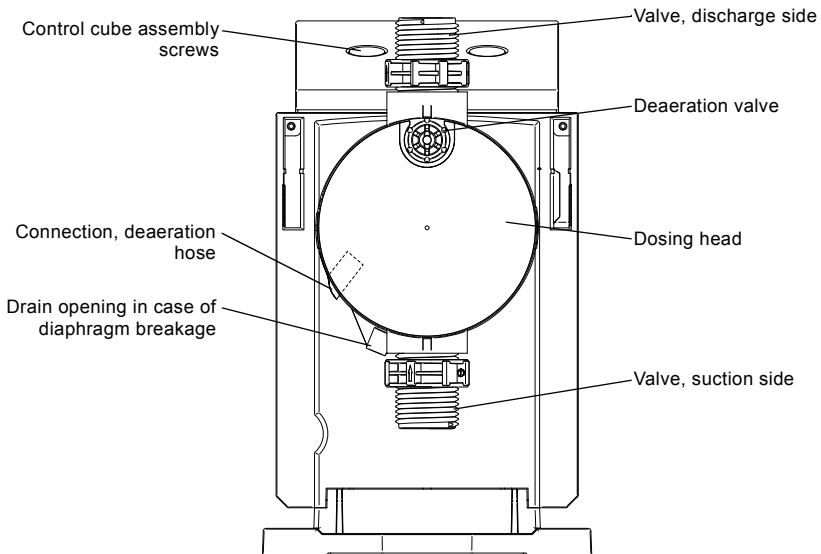

Fig. 3 Rear view of the pump

TM04 1173 3510

TM04 1175 3510

3. Technical data/dimensions



3.1 Technical data

Data		Pump type		
		6-10	9-7	15-4
Turndown ratio (setting range)	[1:X]	1000	1000	1000
	[l/h]	6.0	9.0	15.0
Max. dosing flow	[gph]	1.5	2.4	4.0
	[l/h]	3.00	4.50	7.50
Max. dosing flow with SlowMode 50 %	[gph]	0.75	1.20	2.00
	[l/h]	1.50	2.25	3.75
Max. dosing flow with SlowMode 25 %	[gph]	0.38	0.60	1.00
	[l/h]	0.0060	0.0090	0.0150
Min. dosing flow	[gph]	0.0015	0.0024	0.0040
	[bar]	10	7	4
Max. operating pressure	[psi]	150	100	60
	[Strokes/min]	140	200	180
Max. stroke frequency ¹⁾				
Stroke volume	[ml]	0.81	0.84	1.58
Accuracy of repeatability	[%]	±1		
Max. suction lift during operation ²⁾	[m]	6		
Max. suction lift when priming with wet valves ²⁾	[m]	2	2	3
Min. pressure difference between suction and discharge side	[bar]	1		
	[bar]	2		
Max. pressure, suction side	[bar]	2		
Max. viscosity in SlowMode 25 % with spring-loaded valves ³⁾	[mPas] (= cP)	2500	2000	2000
Max. viscosity in SlowMode 50 % with spring-loaded valves ³⁾	[mPas] (= cP)	1800	1300	1300
Max. viscosity without SlowMode with spring-loaded valves ³⁾	[mPas] (= cP)	600	500	500
Max. viscosity without spring-loaded valves ³⁾	[mPas] (= cP)	50	50	300
Min. diameter of hose/pipe on suction/discharge side ^{2) 4)}	[mm]	4	6	6
Min. diameter of hose/pipe on suction side for highly viscous media (HV) ⁴⁾	[mm]	9		
Min. diameter of hose/pipe on discharge side for highly viscous media (HV) ⁴⁾	[mm]	9		
Max. media temperature	[°C]	45		
Min. media temperature	[°C]	-10		
Max. ambient temperature	[°C]	45		
Min. ambient temperature	[°C]	0		
Max. storage temperature	[°C]	70		
Min. storage temperature	[°C]	-20		

Data		Pump type		
		6-10	9-7	15-4
Electrical data	Voltage	[V]	100-240 V, 50-60 Hz	
	Length of mains cable	[m]	1.5	
	Max. current consumption (100 V)	[A]	8	
	Max. current consumption (230 V)	[A]	25	
	Max. power consumption P ₁	[W]	14	
	Housing enclosure class		IP 65, Nema 4X	
	Electrical safety class		II	
Signal input	Max. load for level input		12 V, 5 mA	
	Max. load for pulse input		12 V, 5 mA	
	Max. load for level input, external stop		12 V, 5 mA	
	Min. pulse length	[ms]	5	
	Max. pulse frequency	[Hz]	100	
	Impedance at 0/4-20 mA analog input	[Ω]	15	
	Max. resistance in level circuit	[Ω]	1000	
Signal output	Max. resistance in pulse circuit	[Ω]	1000	
	Max. ohmic load on relay output	[A]	0.5	
	Max. voltage on relay output	[V]	30 VDC / 30 VAC	
Weight/ size	Impedance at 0/4-20 mA analog output	[Ω]	500	
	Weight (PVC, PP, PVDF)	[kg]	2.4	
	Weight (stainless steel)	[kg]	3.2	
Sound pressure level	Diaphragm diameter	[mm]	44	50
	Max. sound pressure level	[dB(A)]	60	
Approvals		CE, CSA-US, NSF61, GHOST, C-Tick		

¹⁾ The maximum stroke frequency varies depending on calibration

²⁾ Data is based on measurements with water

³⁾ Maximum suction lift: 1 m, dosing flow reduced (approx. 30 %)

⁴⁾ Length of suction line: 1.5 m / length of discharge line: 10 m (at max. viscosity)

3.2 Dimensions

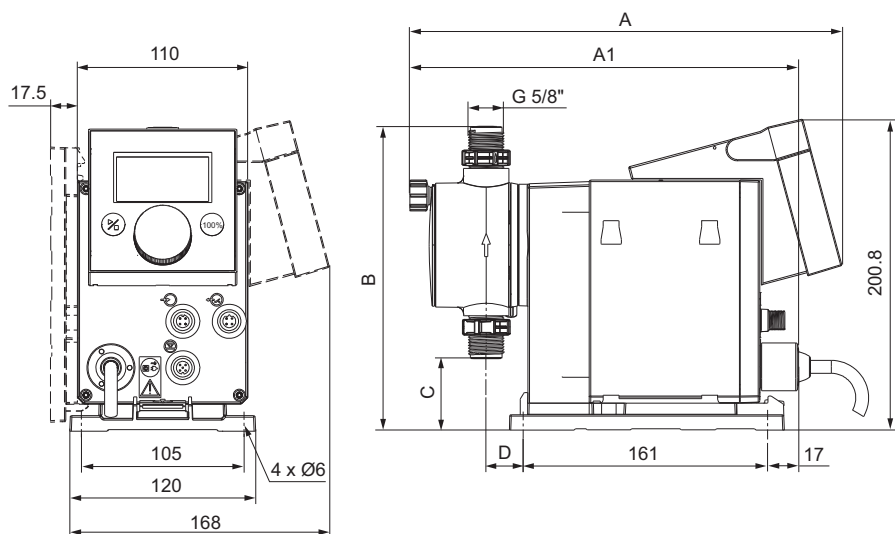

TM04 8169 3510

Fig. 4 Dimensional drawing

Pump type	A [mm]	A1 [mm]	B [mm]	C [mm]	D [mm]
DDC 6-10	280	251	196	46.5	24
DDC 9-7	280	251	196	46.5	24
DDC 15-4	280	251	200.5	39.5	24

4. Assembly and installation



4.1 Pump assembly

The pump is delivered with a mounting plate. The mounting plate can be mounted vertically e.g. on a wall or horizontally e.g. on a tank. It takes just a few quick steps to firmly secure the pump to the mounting plate by means of a slot mechanism.

The pump can easily be released from the mounting plate for maintenance.

4.1.1 Requirements

- The mounting surface must be stable and must not vibrate.
- Dosing must flow upwards vertically.

4.1.2 Align and install mounting plate

- **Vertical installation:** Mounting plate slot mechanism must be above.
- **Horizontal installation:** Mounting plate slot mechanism must be opposite the dosing head.
- The mounting plate can be used as a drill template, please see fig. 4 for drill hole distances.

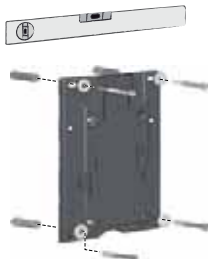

Fig. 5 Locate mounting plate



Warning

Make sure that you do not damage any cables and lines during installation!

1. Indicate drill holes.
2. Drill holes.
3. Secure mounting plate using four screws, diameter 5 mm, to the wall, on the bracket or the tank.

4.1.3 Engage pump in mounting plate

1. Attach the pump to the mounting plate support clamps and slide under slight pressure until it engages.

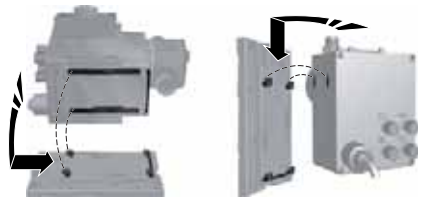

Fig. 6 Engaging the pump

4.1.4 Adjust control cube position

The control cube is fitted to the front of the pump on delivery. It can be turned by 90 ° so that the user can select to operate the pump from the right or left side.



The enclosure class (IP65/Nema 4X) and shock protection are only guaranteed if the control cube is installed correctly!



Pump must be disconnected from the power supply!

1. Carefully remove both protective caps on the control cube using a thin screwdriver.
2. Loosen screws.
3. Carefully lift off control cube only so far from the pump housing that no tensile stress is produced on the flat band cable.
4. Turn control cube by 90 ° and re-attach.
 - Make sure the O-ring is secure.
5. Tighten screws slightly and attach protective caps.



Fig. 7 Adjusting control cube

TM04 1159 0110

TM04 1162 0110

TM04 1182 0110

4.2 Hydraulic connection



Warning

Risk of chemical burns!

Wear protective clothing (gloves and goggles) when working on the dosing head, connections or lines!

The dosing head may contain water from the factory check!

Caution

When dosing media which should not come into contact with water, another medium must be dosed beforehand!

Caution

Faultless function can only be guaranteed in conjunction with lines supplied by Grundfos!

Caution

The lines used must comply with the pressure limits as per section 3.1 Technical data!

Important information on installation

- Observe suction lift and line diameter, see section 3.1 Technical data.
- Shorten hoses at right angles.
- Ensure that there are no loops or kinks in the hoses.
- Keep suction line as short as possible.
- Route suction line up towards the suction valve.
- Installing a filter in the suction line protects the entire installation against dirt and reduces the risk of leakage.

Hose connection procedure

1. Push union nut and tensioning ring across hose.
2. Push cone part fully into hose, see fig. 8.
3. Attach cone part with hose to corresponding pump valve.
4. Tighten union nut manually.
– do not use tools!
5. Tighten up union nuts after 2-5 operating hours if using PTFE gaskets!
6. Attach deaeration hose to the corresponding connection (see fig. 3) and run into a container or a collecting tray.

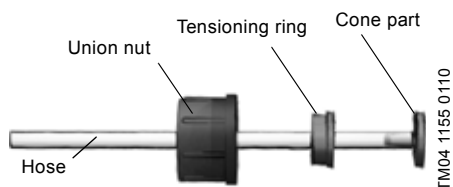

Fig. 8 Hydraulic connection

Note **Pressure differential between suction and discharge side must be at least 1 bar/14.5 psi!**

Caution

Tighten up the dosing head screws once before commissioning and after 2-5 operating hours at 3 Nm.

Installation example

The pump offers various installation options. In the picture below, the pump is installed in conjunction with a suction line, level switch and multifunction valve on a Grundfos tank.

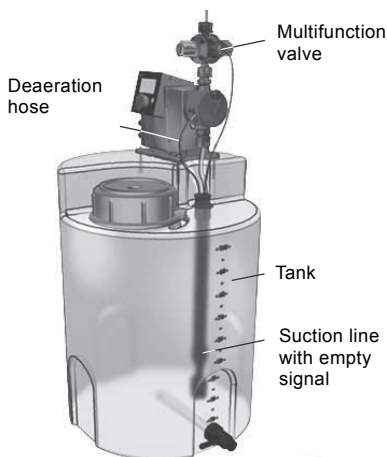

Fig. 9 Installation example

4.3 Electrical connection



Warning

The enclosure class (IP65/Nema 4X) is only guaranteed if plugs or protective caps are correctly installed!



Warning

The pump can start automatically when the mains voltage is switched on!
Do not manipulate mains plug or cable!

The rated voltage of the pump, see section 2.4 Nameplate, must conform to local conditions.

Signal connections

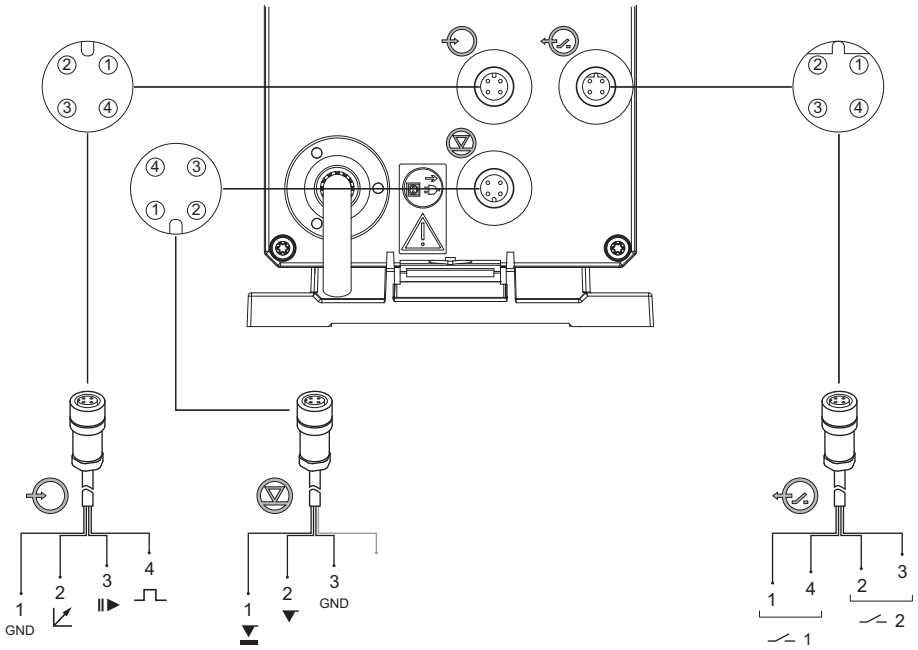

TM04 1187 3410

Fig. 10 Wiring diagram of the electrical connections

Analog, external stop and pulse input

Function	Pins				Plug type
	1/brown	2/white	3/blue	4/black	
Analog	GND/ (-) mA	(+) mA			mA signal
External stop	GND		X		Pulse
Pulse	GND			X	Pulse

Level signals: empty and low-level signal

Function	Pins				Plug type
	1/brown	2/white	3/blue	4/black	
Low-level signal	X		GND		Pulse
Empty signal		X	GND		Pulse

Relay outputs*

Function	Pins				Plug type
	1/brown	2/white	3/blue	4/black	
Relay 1	X			X	Pulse
Relay 2		X	X		Pulse

* applies to DDC-AR control variant

5. Commissioning

5.1 Setting the menu language

For description of control elements, see section 6.

1. Turn click wheel to highlight the cog symbol.
2. Press the click wheel to open the 'Setup' menu.
3. Turn the click wheel to highlight the 'Language' menu.
4. Press the click wheel to open the 'Language' menu.
5. Turn the click wheel to highlight the desired language.
6. Press the click wheel to select the highlighted language.
7. Press the click wheel again to confirm the 'Confirm settings' prompt and apply the setting.

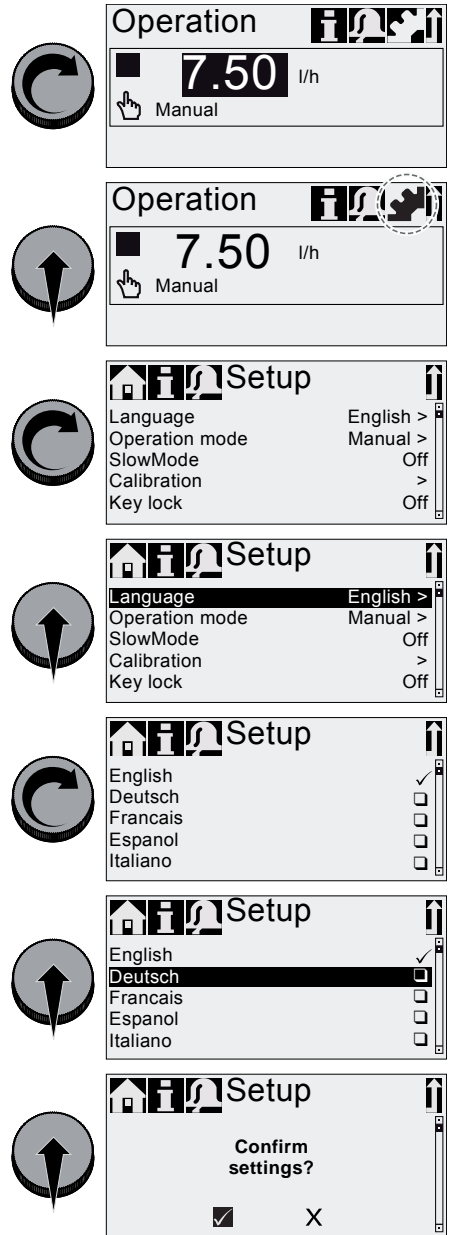

Fig. 11 Set menu language



5.2 Deaerating the pump



Warning

The deaeration hose must be connected correctly and inserted into a suitable tank!

1. Open deaeration screw by approximately half a turn.
2. Press and hold down the 100 % key (deaeration key) until liquid flows continuously without any bubbles from the deaeration hose.
3. Close deaeration screw.

Press the 100 % key and simultaneously turn the click wheel clockwise to increase the duration of the process to up to 300 seconds. After setting the seconds, do not press the key any longer.

Note

5.3 Calibrating the pump

The pump is calibrated in the factory for media with a viscosity similar to water at maximum pump backpressure (see section 3.1 *Technical data*).

If the pump is operated with a backpressure that deviates or if dosing a medium whose viscosity deviates, the pump must be calibrated.

Requirements

- The hydraulics and electrics of the pump are connected (see section 4. *Assembly and installation*).
- The pump is integrated into the dosing process under operating conditions.
- The dosing head and suction hose are filled with dosing medium.
- The pump has been deaerated.

Calibration process - example for DDC 7.5 - 16

1. Fill a measuring beaker with dosing medium.
Recommended filling volumes:

DDC-type	6-10	9-7	15-4
Medium V_1	0.3 l	0.5 l	1.0 l

2. Read off and note down the fill volume V_1 (e.g. 300 ml).
3. Place the suction hose in the measuring beaker.

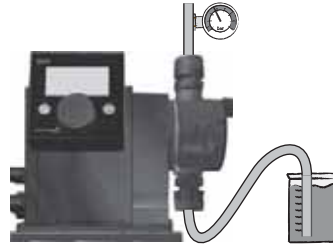
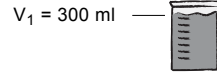

4. Start the calibration process in the 'Setup > Calibration' menu.



5. The pump executes 200 dosing strokes and displays the factory calibration value (e.g. 125 ml).



6. Remove the suction hose from the measuring beaker and check the remaining volume V_2 (e.g. 170 ml).

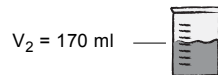

7. From V_1 and V_2 , calculate the actual dosed volume $V_d = V_1 - V_2$ (e.g. 300 ml - 170 ml = 130 ml).

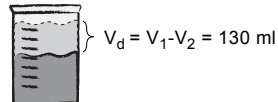

8. Set and apply V_d in the calibration menu.
– The pump is calibrated.



Actual dosed volume V_d ←

6. Operation

6.1 Control elements

The pump control panel includes a display and the following control elements.

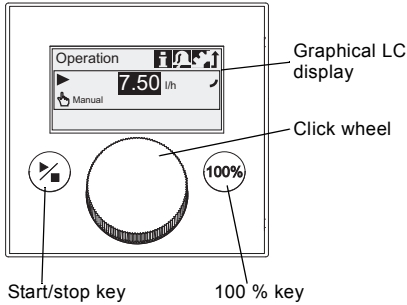

Fig. 12 Control panel

Keys

Key	Function
Start/stop key	Starting and stopping the pump.
100 % key	The pump doses at maximum flow regardless of the operation mode.

Click wheel

The click wheel is used to navigate through the menus, select settings and confirm them.

Turning the click wheel clockwise moves the cursor clockwise in increments in the display. Moving your finger anti-clockwise moves the cursor anti-clockwise.

6.2 Display and symbols

6.2.1 Navigation

In the 'Info', 'Alarm' and 'Setup' main menus, the options and submenus are displayed in the rows below. Use the 'Back' symbol to return to the higher menu level. The scroll bar at the right edge of the display indicates that there are further menu items which are not shown.

The active symbol (current cursor position) flashes. Press the click wheel to confirm your selection and open the next menu level. The active main menu is displayed as text, the other main menus are displayed as symbols. The position of the cursor is highlighted in black in the sub-menu.

When you position the cursor on a value and press the click wheel, a value is selected. Turning the click wheel clockwise increases the value, turning the click wheel anti-clockwise reduces the value. When you now press the click wheel, the cursor will be released again.

6.2.2 Operating states

The operating state of the pump is indicated by a symbol and display colour.

Display	Fault	Operating state		
White	-	Stop ■	Standby 	
Green	-			Running ▶
Yellow	Warning	Stop ■	Standby 	Running ▶
Red	Alarm	Stop ■	Standby 	

6.2.3 Sleep mode (energy-saving mode)

If in the 'Operation' main menu the pump is not operated for 30 seconds, the header disappears. After 2 minutes, the display switches to the 'Operation' main menu and the display brightness is reduced. This state will be cancelled when the pump is operated or a fault occurs.

TM04 1188 3510

6.2.4 Overview of display symbols

The following display symbols may appear in the menus.

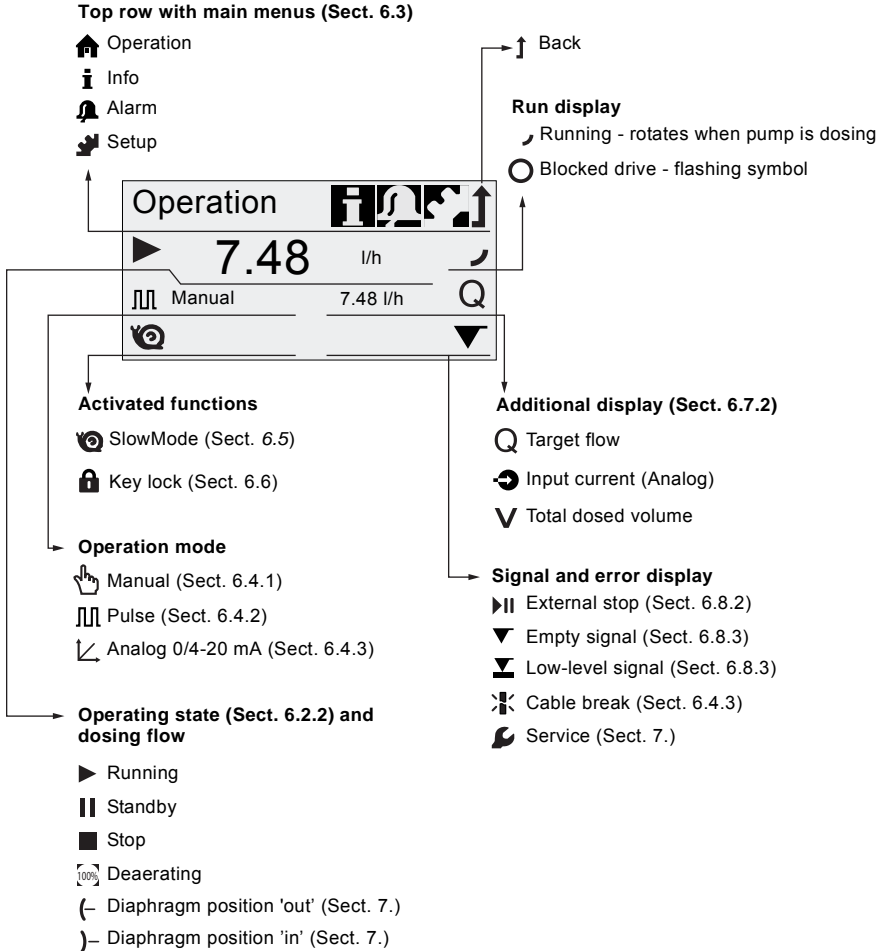

Fig. 13 Overview of display symbols

6.3 Main menus

The main menus are displayed as symbols at the top of the display. The currently active main menu is displayed as text.

6.3.1 Operation

Status information such as the dosing flow, selected operation mode and operating state is displayed in the 'Operation' main menu.

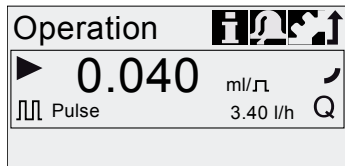

TM04 1126 1110



6.3.2 Info

You can find the date, time and information about the active dosing process, various counters, product data and the service system status in the 'Info' main menu. The information can be accessed during operation.

The service system can also be reset from here.

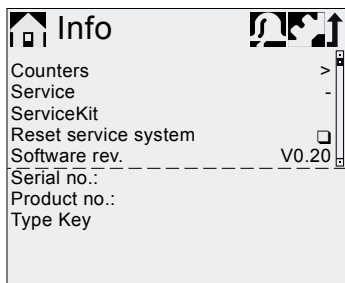

TM04 1106 1010

Counters

The 'Info > counters' menu contains the following counters:

Counters	resettable
Volume	
Total dosed volume [l] or US gallons	Yes
Operating hours	
Accumulated operating hours (pump switched on) [h]	No
Motor runtime	
Accumulated motor runtime [h]	No
Strokes	
Accumulated number of dosing strokes	No
Power on/off	
Accumulated frequency of switching mains voltage on	No

6.3.3 Alarm

You can view errors in the 'Alarm' main menu.

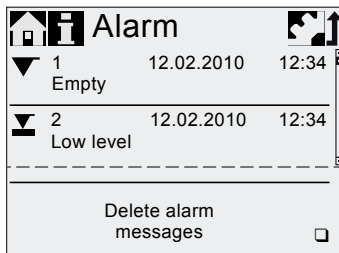

TM04 1109 1010

Up to 10 warnings and alarms, together with their date, time and cause, are listed in chronological order. If the list is full, the oldest entry will be overwritten, see Section 8. *Faults*.

6.3.4 Setup

The 'Setup' main menu contains menus for pump configuration. These menus are described in the following sections.

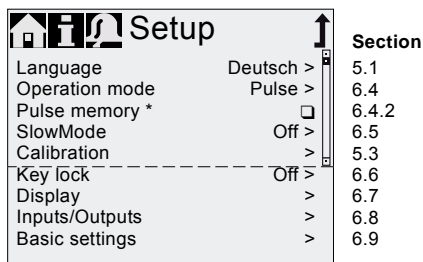

TM04 8166 3510

* Menu 'Pulse memory' is only displayed in operation mode 'Pulse'.

6.4 Operation modes

Three different operation modes can be set in the 'Setup > Operation mode' menu.

- **Manual**, see section 6.4.1
- **Pulse**, see section 6.4.2
- **Analog 0-20 mA**, see section 6.4.3
- **Analog 4-20 mA**, see section 6.4.3

6.4.1 Manual

In this operation mode, the pump constantly doses the dosing flow set with the click wheel. The dosing flow is set in l/h or ml/h. The pump automatically switches between the units. Alternatively, the display can be reset to US units (gph).

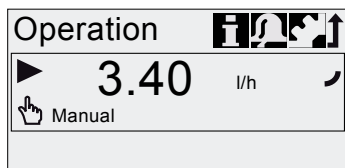

Fig. 14 Manual mode

The setting range depends on the pump type:

Type	Setting range*	
	l/h	gph
DDC 6-10	0.0060 - 6.0	0.0015 - 1.5
DDC 9-7	0.0090 - 9.0	0.0024 - 2.4
DDC 15-4	0.0150 - 15.0	0.0040 - 4.0

* When the SlowMode function is active, the maximum dosing flow is reduced, see section 3.1 *Technical data*.

6.4.2 Pulse

In this operation mode, the pump doses the set dosing volume for each incoming (potential-free) pulse, e.g. from a water meter. There is no direct connection between incoming pulses and dosing strokes. The pump automatically calculates the optimum stroke frequency for dosing the set volume per pulse.

The calculation is based on:

- the frequency of external pulses
- the set dosing volume/pulse.

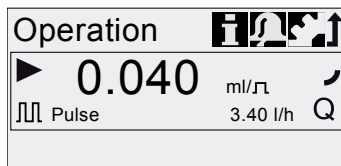

Fig. 15 Pulse operation mode

The dosing volume per pulse is set in ml/pulse using the click wheel. The setting range for the dosing volume depends on the pump type:

Type	Setting range [ml/Pulse]
DDC 6-10	0.0016 - 16.2
DDC 9-7	0.0017 - 16.8
DDC 15-4	0.0032 - 31.6

The frequency of incoming pulses is multiplied by the set dosing volume. If the pump receives more pulses than it can process at the maximum dosing flow, it runs at the maximum stroke frequency in continuous operation. Excess pulses will be ignored if the memory function is not enabled.

Memory function

When the 'Setup > Pulse memory' function is enabled, up to 65,000 unprocessed pulses can be saved for subsequent processing.

The contents of the memory will be deleted when:

Note

- switching off the power supply
- switching the operating mode
- the pump is interrupted (e.g. alarm, external stop).



TM04 8170 3510

TM04 1126 1110

6.4.3 Analog 0/4-20 mA

Applies to DDC-AR control variant

In this operation mode, the pump doses according to the external analog signal. The dosing volume is proportional to the signal input value in mA.

Operation mode	Input value	Dosing flow
4-20 mA	≤ 4.1 mA	0 %
	≥ 19.8 mA	100 %
0-20 mA	≤ 0.1 mA	0 %
	≥ 19.8 mA	100 %

If the input value in operation mode 4-20 mA falls below 2 mA, an alarm is displayed and the pump stops. A cable break or signal transmitter error has occurred. The 'Cable break' symbol is displayed in the 'Signal and error display' area of the display.

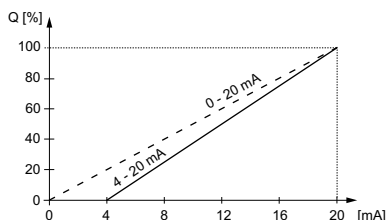

Fig. 16 Analog scaling

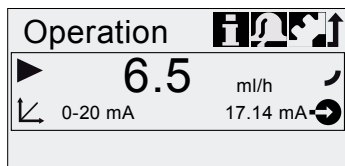

Fig. 17 Analog operation mode

6.5 SlowMode

When the 'SlowMode' function is enabled, the pump slows down the suction stroke. The function is enabled in the 'Setup > SlowMode' menu and is used to prevent cavitation in the following cases:

- for dosing media with a higher viscosity
- for degassing dosing media
- for long suction lines
- for large suction lift.

In the 'Setup > SlowMode' menu, the speed of the suction stroke can be reduced to 50 % or 25 %.

Caution Enabling the 'SlowMode' function reduces the maximum dosing flow of the pump to the set percentage value!

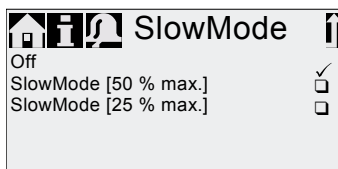

Fig. 18 SlowMode menu

6.6 Key lock

The key lock is set in the 'Setup > Key lock' menu by entering a four-digit code. It protects the pump by preventing changes to settings. Two levels of key lock can be selected:

Level	Description
Settings	All settings can only be changed by entering the lock code. The start/stop key and the 100 % key are not locked.
Settings + keys	The start/stop key and the 100 % key and all settings are locked.

It is still possible to navigate in the 'Alarm' and 'Info' main menu and reset alarms.

Temporary deactivation

If the key lock function is activated but settings need to be modified, the keys can be unlocked temporarily by entering the deactivation code. If the code is not entered within 10 seconds, the display automatically switches to the 'Operation' main menu. The key lock remains active.

Deactivation

The key lock can be deactivated in the 'Setup > Key lock' menu via the 'Off' menu point. The key lock is deactivated after the general code '2583' or a pre-defined custom code has been entered.

TM04 1120 2010

TM04 1127 1110

TM04 1153 1110

6.7 Display Setup

Use the following settings in the 'Setup > Display' menu to adjust the display properties:

- Units (metric/US)
- Display contrast
- Additional display

6.7.1 Units

Metric units (litres/millilitres/bar) or US units (US gallons/PSI) can be selected. According to the operation mode and menu, the following units of measurement are displayed:

Operation mode/function	Metric units	US units
Manual control	ml/h or l/h	gph
Pulse control	ml/□	ml/□
0/4-20 mA Analogue control	ml/h or l/h	gph
Calibration	ml	ml
Volume counter	l	gal

6.7.2 Additional display

Additional display provides additional information about the current pump status. The value is shown in the display with the corresponding symbol.

In 'Pulse' mode the 'Target flow' information can be displayed with Q = 1.28 l/h (see fig. 19).

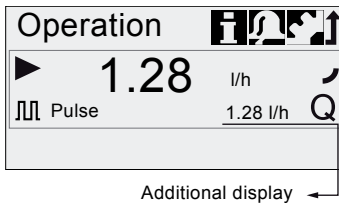

Fig. 19 Display with additional display

The additional display can be set as follows:

Setting	Description
Default display	Q Target flow (pulse)
	→ Input current (analog) ¹⁾
Dosed volume	V Dosed vol. since last reset (see <i>Counters</i> on page 20)

¹⁾ only DDC-AR control variant

6.8 Inputs/outputs

In the 'Setup > Inputs/outputs' menu, you can configure the two outputs 'Relay 1+2' and the signal inputs 'External stop', 'Empty signal' and 'Low level signal'.

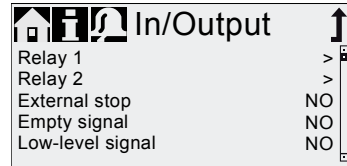

TM04 1152 1110

Fig. 20 'Setup > Inputs/outputs' menu

6.8.1 Relay outputs

Applies to DDC-AR control variant

The pump can switch two external signals using installed relays. The relays are switched by potential-free pulses. The connection diagram of the relays is shown in section 4.3 *Electrical connection*. Both relays can be allocated with the following signals:

Relay 1 signal	Relay 2 signal	Description
Alarm*	Alarm	Display red, pump stopped (e.g. empty signal, etc.)
Warning*	Warning	Display yellow, pump is running (e.g. low-level signal, etc.)
Stroke signal	Stroke signal*	each full stroke
Pump dosing	Pump dosing	Pump running and dosing
Contact type		
NO*	NO*	Normally open contact
NC	NC	Normally closed contact

* Factory setting

TM04 8167 3510

6.8.2 External stop



The pump can be stopped via an external pulse, e.g. from a control room. When activating the external stop pulse, the pump switches from the operational state 'Running' into the operational state 'Standby'. The corresponding symbol appears in the Signal/error display (see section 6.2.2 *Operating states*).

Frequent disengagement from the mains voltage, e.g. via a relay, can result in damage to the pump electronics and to the breakdown of the pump. The dosing accuracy is also reduced as a result of internal start procedures.

Caution

Do not control the pump via the mains voltage for dosing purposes!



Only use the 'External stop' function to start and stop the pump!

The contact type is factory-set to closing contact (=>NO). In the 'Setup > Inputs/outputs > External stop' menu, the setting can be changed to opening contact (=>NC).

6.8.3 Empty and low-level signals



In order to monitor the fill level in the tank, a dual-level control unit can be connected to the pump. The pump responds to the signals as follows:

Fill level sensor	Pump status
Low level	<ul style="list-style-type: none"> • Display is yellow •  flashes • Pump continues running
Empty	<ul style="list-style-type: none"> • Display is red •  flashes • Pump stops

Both signal inputs are allocated to the closing contact (=>NO) in the factory. They can be re-allocated in the 'Setup > Inputs/outputs' menu to opening contact (=>NC).

6.9 Basic settings

All settings can be reset to the settings default upon delivery in the 'Setup > Basic settings' menu.

Selecting 'Save customer settings' saves the current configuration to the memory. This can then be activated using 'Load customer settings'.

The memory always contains the previously saved configuration. Older memory data is overwritten.

7. Service



In order to ensure a long service life and dosing accuracy, wearing parts such as diaphragms and valves must be regularly checked for signs of wear. Where necessary, replace worn parts with original spare parts made from suitable materials.

Should you have any questions, please contact your service partner.

Warning

If the diaphragm leaks or is broken, dosing liquid will escape from the discharge opening on the dosing head (see fig. 3).



Take suitable precautions to prevent harm to health and damage to property caused by escaping dosing liquid! Check daily whether liquid is escaping from the discharge opening!

7.1 Service system

According to the motor runtime service requirements will appear. Service requirements appear regardless of the current operational state of the pump and do not affect the dosing process. If no service requirement has occurred, service has to be performed at least every two years.

Service requirement	Motor runtime [h]*
'Service soon'	7500
'Service now'	8000

* Since the last service system reset

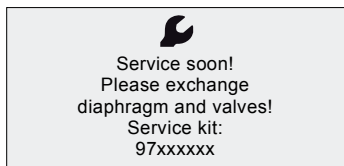

Fig. 21 'Service soon'

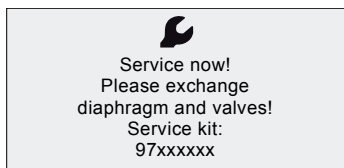



Fig. 22 'Service now'

The service requirement signals when the replacement of wearing parts is due and displays the number of the service kit. Press the click wheel to temporarily hide the service prompt.

When the 'Service now' message appears (displayed daily), the pump must be serviced immediately. To signalise in the 'Operation' menu, the symbol  appears in the 'Signal/error display' area of the display.

The number of the service kit required is also displayed in the 'Info' menu.

For media which result in increased wear, the service interval must be shortened.

7.2 Perform service

Only spare parts and accessories from Grundfos should be used for maintenance. The usage of non-original spare parts and accessories renders any liability for resulting damages null and void.

Information about carrying out maintenance can be found in the service kit catalog on our homepage www.grundfosalldos.com.

Warning

When dosing dangerous media, observe the corresponding precautions in the safety data sheets!

Risk of chemical burns!

Wear protective clothing (gloves and goggles) when working on the dosing head, connections or lines!

Do not allow any chemicals to leak from the pump. Collect and dispose of all chemicals correctly!



Before any work to the pump, the pump must be in the 'Stop' operational state or be disconnected from the mains. The system must be pressureless!



7.2.1 Dosing head overview

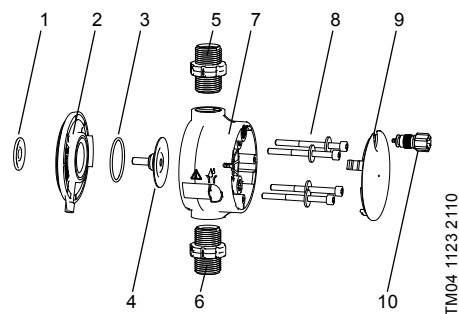

Fig. 23 Dosing head, exploded view

1	Safety diaphragm
2	Flange
3	O-ring
4	Diaphragm
5	Valve on discharge side
6	Valve on suction side
7	Dosing head
8	Screws with discs
9	Cover
10	Deaeration valve

7.2.2 Dismantling the diaphragm and valves

1. Make system pressureless.
2. Empty dosing head before maintenance and flush it if necessary.
3. Set pump to 'Stop' ■ operational state using the 'Start/stop key'.
4. Press the 'Start/stop' and '100 %' keys at the same time to put the diaphragm into 'out' position.
 - Symbol ← must be displayed as the operational state (see fig. 13).
5. Take suitable steps to ensure that the returning liquid is safely collected.
6. Dismantle suction, pressure and deaeration hose.
7. Dismantle valves on suction and discharge side (5, 6).
8. Remove the cover (9).
9. Loosen screws (8) on the dosing head (7) and remove with discs.
10. Remove the dosing head (7).
11. Unscrew diaphragm (4) counter-clockwise and remove with flange (2).

7.2.3 Reassembling the diaphragm and valves

1. Attach flange (2) correctly and screw on new diaphragm (4) clockwise.
 - Make sure that the O-ring (3) is seated correctly!
2. Press the 'Start/stop' and '100 %' keys at the same time to put the diaphragm into 'in' position.
 - Symbol }– must be displayed as the operational state (see fig. 13).
3. Attach the dosing head (7).
4. Install screws with discs (8) and cross-tighten.
 - Torque: 3 Nm.
5. Attach the cover (9).
6. Install new valves (5, 6).
 - Do not interchange valves and pay attention to direction of arrow.
7. Connect suction, pressure and deaeration hose (see section 4.2 *Hydraulic connection*)
8. Press the "Start/Stop" key to leave the service mode.
9. Deaerate dosing pump (see section 5.2 *Deaerating the pump*).
10. Please observe the notes on commissioning in section 5. *Commissioning*!

7.3 Resetting the service system

After performing the service, the service system must be reset using the 'Info > Reset service system' function.

7.4 Repairs

Warning

The pump housing must only be opened by personnel authorised by Grundfos!



Repairs must only be carried out by authorised and qualified personnel!

Switch off the pump and disconnect it from the voltage supply before carrying out maintenance work and repairs!

After consulting Grundfos, please send the pump, together with the safety declaration completed by a specialist, to Grundfos. The safety declaration can be found at the end of these instructions. It must be copied, completed and attached to the pump.

If the pump has been used to dose toxic liquids or liquids hazardous to health, the pump must be cleaned prior to dispatch!

Caution

If the above requirements are not met, Grundfos may refuse to accept delivery of the pump. The shipping costs will be charged to the sender.

8. Faults



In the event of faults in the dosing pump, a warning or an alarm is triggered.

The corresponding fault symbol flashes in the 'Operation' menu, see section 8.1 *List of faults*. The cursor jumps to the 'Alarm' main menu symbol. Press the click wheel to open the 'Alarm' menu and, where necessary, faults to be acknowledged will be acknowledged.

A yellow display indicates a warning and the pump continues running.

A red display indicates an alarm and the pump is stopped.

The last 10 faults are stored in the 'Alarm' main menu. When a new fault occurs, the oldest fault is deleted.

The two most recent faults are shown in the display, you can scroll through all the other faults. The time and cause of the fault are displayed.

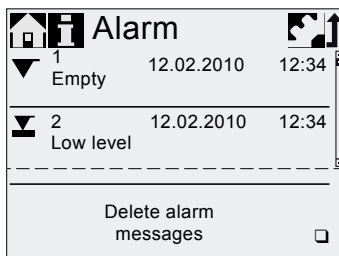

TM04 1109 1010

The list of faults can be deleted at the end of the list. If there is a service requirement, this appears when the 'Alarm' menu is opened. Press the click wheel to temporarily close the service prompt (see section 7.1 *Service system*).

8.1 List of faults

8.1.1 Faults with error message

Display in the 'Alarm' menu	Possible cause	Possible remedy
▼ Empty (Alarm)	<ul style="list-style-type: none"> Dosing medium tank empty 	<ul style="list-style-type: none"> Fill tank. Check contact setting (NO/NC)
⚠ Low level (Warning)	<ul style="list-style-type: none"> Dosing medium tank almost empty 	
○ Motor blocked (alarm)	<ul style="list-style-type: none"> Backpressure greater than nominal pressure Damage to gears 	<ul style="list-style-type: none"> Reduce backpressure. Arrange for repair to drive if necessary.
⚡ Cable break (Alarm)	<ul style="list-style-type: none"> Defect in analog line 4-20 mA (input current < 2 mA) 	<ul style="list-style-type: none"> Check line/plug connections and replace, if necessary. Check signal transmitter.
🕒 Service soon/now (Warning)	<ul style="list-style-type: none"> Time interval for service expired 	<ul style="list-style-type: none"> Perform service (see section 7.2 <i>Perform service</i>).

8.1.2 General faults

Fault	Possible cause	Possible remedy	
Dosing flow too high	Inlet pressure greater than backpressure	Install additional spring-loaded valve (approx. 3 bar) on the discharge side. Increase pressure differential.	
	Incorrect calibration	Calibrate the pump (see section 5.3 <i>Calibrating the pump</i>).	
No dosing flow or dosing flow too low	Air in dosing head	Deaerate the pump.	
	Faulty diaphragm	Change the diaphragm (see section 7.2 <i>Perform service</i>).	
	Leakage/fracture in lines	Check and repair lines.	
	Valves leaking or blocked	Check and clean valves.	
	Valves installed incorrectly	Check that the arrow on the valve housing is pointing in the direction of flow. Check whether all O-rings are installed correctly.	
	Blocked suction line	Clean suction line/install filter. Reduce suction lift.	
	Suction lift too high	Install priming aid. <i>Enable 'Slow Mode'</i> (see section 6.5 <i>SlowMode</i>).	
	Viscosity too high		<i>Enable 'Slow Mode'</i> (see section 6.5 <i>SlowMode</i>).
			Use hose with larger diameter.
			Install spring-loaded valve on the discharge side.
Pump outside the calibration	Calibrate the pump (see section 5.3 <i>Calibrating the pump</i>).		
Deaeration valve open	Close the deaeration valve.		
Irregular dosing	Valves leaking or blocked	Tighten up valves, replace valves if necessary (see section 7.2 <i>Perform service</i>).	
	Backpressure fluctuations	Keep backpressure constant.	
Liquid escaping from the discharge opening on the flange	Faulty diaphragm	Change the diaphragm (see section 7.2 <i>Perform service</i>).	
Liquid escaping	Dosing head screws not screwed in as far as they will go	Tighten up screws (see section 4.2 <i>Hydraulic connection</i>).	
	Valves not screwed in as far as they will go	Tighten up valves/union nuts (see section 4.2 <i>Hydraulic connection</i>).	
Pump not sucking in	Suction lift too high	Reduce suction lift, if necessary provide positive inlet pressure.	
	Backpressure too high	Open the deaeration valve.	
	Soiled valves	Flush system, replace valves if necessary (see section 7.2 <i>Perform service</i>).	

9. Disposal

This product and all its associated parts must be disposed of in an environmentally friendly manner. Use appropriate waste collection services. If there is no such facility or the facility refuses to accept these materials used in the product, the product can be sent to the nearest Grundfos company or service centre.



Safety declaration

Please copy, fill in and sign this sheet and attach it to the pump returned for service.

Product type (nameplate) _____

Model number (nameplate) _____

Dosing medium _____

Fault description

Please make a circle around the damaged parts.

In the case of an electrical or functional fault, please mark the cabinet.

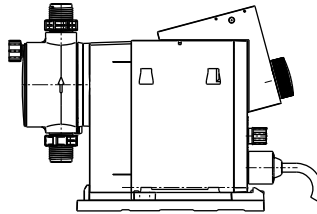
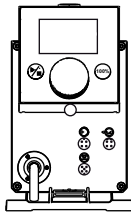

TM04 8168 3510

Please describe the error / cause of the error in brief.

We hereby declare that the pump has been cleaned and is completely free from chemical, biological and radioactive substances.

Date and signature

Company stamp

Distributed by:
Astles Control Systems Ltd.
B3 Regent Park
Summerleys Road
Princes Risborough
HP27 9LE

T: 0044 (0) 1844 273301
F: 0044 (0) 1844 343530
E: sales@astles.co.uk